

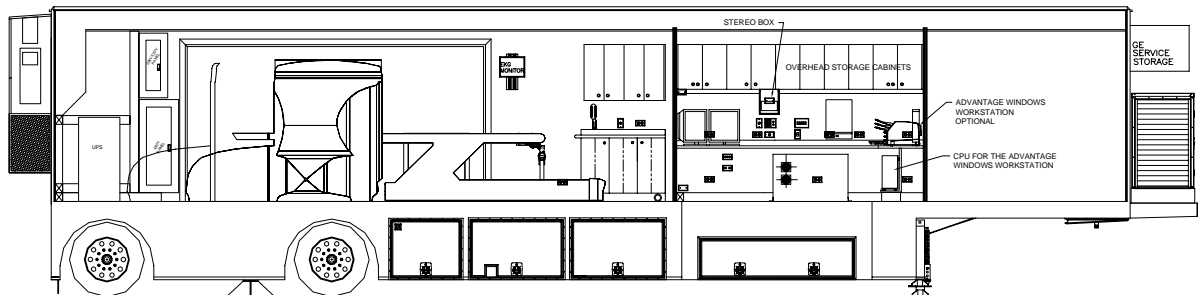

Site Planning Guide

GE DISCOVERY ST Mobile PET/CT System 48' L x 8'-6" W x 13'-6" H USA Unit



© 2006 Oshkosh Specialty Vehicles

This guide contains confidential information of Oshkosh Specialty Vehicles. You may not copy it or any part of it without the written permission of Oshkosh Specialty Vehicles. This manual may be used only by you, and only for the purposes for which it was intended. You may not disclose this manual or the confidential information it contains outside of your company. If you wish to copy any part of this manual, or to use it other than as described above, you must contact Oshkosh Specialty Vehicles seeking permission to do so.

North America

Corporate Headquarters
Oshkosh Specialty Vehicles
16745 South Lathrop Ave.
Harvey, IL
60426
USA
(001) 708.596.5066

Europe

Oshkosh Specialty Vehicles, Ltd.
Unit 17, Nelson Way
Tuscum Trading Estate,
Camberley, Surrey
GU15 3DH
United Kingdom
(44) 01276.64490

Buys Ballotstraat 6
3261 LA Oud-Beijerland, Holland
+31 (0) 186-614322
Fax: +31 (0) 186-619367
E-mail: smit@smit-mobile.nl

List of Revisions

Revisions

00	Initial release	October 2002
01	Added Ground Connection Clarification	January 2003
02	Updated Drawings	November 2003
03	Updated Specs & Added A/C Clearance Requirement	August 2004
04	Corrected trailer weight	October 2004
07	Patient to Platform & Current Design Info	October 2006
08	Updated Logo & Company Reference	October 2006

Notice

In accordance with our policy of continued product improvement, Oshkosh Specialty Vehicles reserves the right to make changes in the equipment, design, specifications, and materials of the product described herein. Any problems or questions related to the components or systems covered in this booklet may be directed to:

Oshkosh Specialty Vehicles
Attention: Service Department
16745 South Lathrop Avenue
Harvey, Illinois
60426
USA

Telephone: (001) 800.839.0630 (24/7 Service)

Fax: (001) 708.596.2480

<http://www.oshkoshsv.com>

Table of Contents

<u>Introduction.....</u>	<u>5</u>
Warnings & Safety Alert Conventions	5
<u>Support Pad Requirements</u>	<u>6</u>
Trailer Weight	6
Recommended Support Pad Requirements	6
Support Pad Depth	6
Support Pad Levelness	6
Recommended Service Pad.....	6
Electro Magnetic Interference	6
Vehicle Access	7
Recommended Attachment to the Facility	7
Swing Clearance Note.....	7
Air Conditioning Air Flow Clearance.....	7
<u>Radiation Shielding Requirements</u>	<u>8</u>
Radiation Shielding.....	8
Radiation Field Information	8
<u>Customer Power Requirements</u>	<u>9</u>
Lockout/Tagout.....	9
Electrical Service	9
Configuration	9
Load Regulation at Line Frequency	9
Frequency.....	9
Connector Type	9
Customer Facility.....	9
Input Power	10
Power Source Monitoring (Facility Only)	10
<u>Mobile Grounding Requirements</u>	<u>11</u>
Special Ground Note	11
Mobile Grounding Chart	12
<u>Telephone and Data Service Requirements</u>	<u>13</u>
Telephone Service.....	13
Data Service	13
<u>Water Requirements.....</u>	<u>14</u>
Water Supply Tank.....	14
Portable Sink (optional)	14

Table of Figures

Figure 1: Ground Connection	11
Figure 2: Plan Layout	15
Figure 3: Right Side Elevation.....	16
Figure 4: Left Side Elevation	17
Figure 5: Radiation Shielding Plan View	18
Figure 6: Stair / Lift / Wall Elevation	19
Figure 7: Russellstoll Receptacle, Service Disconnect.....	20
Figure 8: Russellstoll Receptacle Chart.....	21
Figure 9: Turning Requirements	22

Introduction

The purpose of this document is to provide the basic information needed for site planning. For specific information not contained in this document, please contact Oshkosh Specialty Vehicles.

The mobile unit requires sufficient room to be maneuvered and positioned for setup and takedown. The mobile unit has many storage compartments and service doors that require access during these procedures as well as during operation. The expanding wall sections, platform lift, entry stairs, and optional platform require additional space on the right side of the mobile unit. Refer to the drawings provided for actual locations of doors, platform lift, and stair sizes and locations.

Warnings & Safety Alert Conventions

Three types of statements are used throughout this document to warn the operator of potential situations. Always read these statements carefully and take the appropriate safety precautions to ensure a safe environment for all personnel and all property. The statements are as follows:



This type of notice indicates a potentially hazardous situation, which if not avoided, could result in injury or death to the operator of the mobile unit.



This type of notice indicates a potentially hazardous situation, which if not avoided, could result in irreparable damage to the mobile unit.



This type of notice is meant to inform the operator of useful information.

Support Pad Requirements

IMPORTANT

If other modalities utilize the same support pad, it is recommended that non-ferrous reinforcement materials be used for pad reinforcement.

IMPORTANT

GE must approve plans for pad construction.

The following is a list of recommendations and requirements for a concrete support pad. However, due to varying site conditions, the actual pad design should be prepared by an appropriately licensed structural or architectural engineer.

Trailer Weight

The weight of the trailer should be considered in the design of the support and service pads. The overall weight of the trailer is approximately 60,580 lbs. The weight on the rear axles is approximately 37,840 lbs. The weight on the King Pin is approximately 22,740 lbs.

Recommended Support Pad Requirements

The measurements for the recommended support pad are as follows, 10'-11" x 40'-8". The cross hatching as shown on [Figure 2: Plan Layout](#) and [Figure 3: Right Side Elevation](#) represents the recommended support pad.

Support Pad Depth

Recommendations for the width and length of the pad are given above. Based upon the existing site conditions, the depth should be determined by a local contractor.

Support Pad Levelness

In order to ensure proper operation of the PET/CT system, the support pad(s) must be level and the deviation must not exceed .125" in 10'-0".

Recommended Service Pad

The measurements for the recommended service pad are as follows, 21'-0" x 58'-0". This will allow full service access to the mobile unit. The recommended service pad is shown on [Figure 2: Plan Layout](#) and [Figure 3: Right Side Elevation](#).

Electro Magnetic Interference

The ambient static magnetic field within the region of the gantry should not exceed 1 Gauss (10^{-4} Tesla) peak at the detector.

Vehicle Access

A firm, level surface is required around the mobile unit in order to provide access to the site, patient access to the mobile unit, and servicing of the mobile unit.

Recommended Attachment to the Facility

An inflatable air bag or soft seal is recommended at the point of connection from the unit to the facility. Fixed or solid connections may hinder imaging quality. Contact Oshkosh Specialty Vehicles or the local GE representative prior to construction if the proposed connection varies from the recommended.

Swing Clearance Note

Please verify the actual dimensions of the rearmost projections on the cab of your tractor to the centerline of tandem suspension or centerline of the fifth wheel plate on your tractor. Refer to [Figure 9: Turning Requirements](#) for proper tractor sizing information.

Air Conditioning Air Flow Clearance

The following clearances for acceptable air conditioning condenser air flow have been established between wall-mounted equipment and opposing units or surfaces for maximum capacity, lowest operating cost, satisfactory operation of ventilation packages, and longest service life

- Unit discharging against opposing (facing) unit – 20 feet from coil grill to coil grill
- Unit discharging against a wall or essentially solid barrier – 15 feet from coil grill to wall.

See [Figure 2: Plan Layout](#).

Radiation Shielding Requirements

Radiation Shielding

IMPORTANT

Radiation exposure limits must be in accordance with all local, state, and federal requirements. It is the responsibility of the customer to perform a proper radiation survey in order to determine the exclusion zone.

Care should be taken when determining a site location. Factors such as shielding design, proximity to buildings, and occupancy of the surrounding areas must be considered. An exclusion zone around the mobile unit may be necessary. Refer to [Figure 5: Radiation Shielding Plan View](#) for additional information.

Radiation Field Information

It is the responsibility of the customer to ensure a safe environment with respect to the radiation field. Due to radioactivity levels associated with pet patient handling and diagnostic procedures used in PET/CT scanning, an exclusion zone must be maintained while in use.

Customer must contact their local Radiation Safety Operation Official for the federal, state, and local guidelines and must comply with these safety requirements.

Operator needs to make their own exposure dose measurements to include radiation from patients when determining the outside "Keep Away Zone" (chained-off area).

Customer Power Requirements



It is the operator's responsibility to verify that the shore power receptacle is of the same type and voltage as the connection that is supplied by Oshkosh Specialty Vehicles. Failure to do this can result in injury or death to the operator of the mobile unit as well as irreparable damage to the mobile unit.



The standard connector for the unit is a Russellstoll DS2504MP 480V 200A Plug. If an existing site currently implements a different connector or connector configuration, please contact Oshkosh Specialty Vehicles in order to arrange for a compatible power connector before the unit leaves the facility.

Lockout/Tagout

A Lockout/Tagout provision in accordance with OSHA Standard 1910.147 is required. The facility shore power disconnect device must be located within 40'-0" of the unit and must provide for an effective lockout/tagout to facilitate safe service and maintenance of the unit.

Electrical Service

A single electrical power source is required for operation of the PET/CT system. 3/N/PE AC 480V service fused at 150 amperes.

Configuration

Three phase, five wire, wye connection, with neutral and ground. (5 wire 3/N/PE AC 480V)

Load Regulation at Line Frequency

Wires are to be sized such that the line voltage drops from the power source to the mobile unit is less than 2.5% of the nominal voltage for the rated load of the mobile unit.

Frequency

60Hz \pm 2.0Hz.

Phase Balance

The phase balance is 3% maximum of lowest phase-to-phase voltage.

Maximum Voltage Variation

The maximum voltage variation is +11% / -4% from a nominal steady state (under the worst case conditions of line voltage).

Connector Type

The mobile unit is supplied with a 35'-0" useable power cable and male conductor. Unless otherwise specified, the connector type is a Russellstoll DS2504MP000/DF2032 480V 200A rated plug.

Customer Facility

The customer facility must have the matching receptacle as specified in [Figure 7: Russellstoll Receptacle, Service Disconnect](#) and Figure 8: Russellstoll Receptacle Chart. Unless otherwise specified, the receptacle type to be used must be a Russellstoll DF2504FRAB0 female connector.

Input Power

- Frequency: 60Hz \pm 2.0Hz
- Regulation: Load regulation must not exceed 2.5%.
- Phase Imbalance: The difference between the highest line-to-line voltage and lowest line-to-line voltage must not exceed 3% of the lowest line-to-line voltage.

Power Source Monitoring (Facility Only)

NOTE: Perform a power audit first.

A power analyzer should be used to check the proposed Mobile Discovery ST PET/CT Series facility site power for average line voltage, surges, sags, reclosures, impulses, frequency and microcuts. A period that includes two weekends should be used to simulate several days of normal use. Analysis of the data and site history of any previous power problems with other X-ray systems or computer installations should be reviewed with your power and ground representative. Verify "brown-out" (low voltage) conditions, which may occur during summer months, will not exceed the allowable range.

Some analyzer models that are suitable for power monitoring are:

- Dranetz Model 658
- Dranetz Model 656A
- BMI 3630
- RPM

Mobile Grounding Requirements

Special Ground Note

The mobile unit must have an earth driven ground rod within 5'-0" of the facility power receptacle. A grounding cable of a minimum #1/0 AWG must be connected between the grounding rod and the grounding pin of the facility power receptacle. Another cable to be kept as short as possible may also be connected between the ground stud on the Automatic Transfer Switch and an earth driven ground rod. See [Figure 1: Ground Connection](#) below. A separate grounding conductor must still be run with the phase conductors to the source of the power from the grounding pin of the hospital power receptacle in accordance with NEC 2002 Article 250-24.



[Figure 1: Ground Connection](#)

Mobile Grounding Chart

MOBILE GROUNDING REQUIREMENTS

NOTE:

- ALL WORK TO BE DONE IN ACCORDANCE WITH NATIONAL AND LOCAL ELECTRICAL CODES INFORMATION SHOWN HERE IS ONLY A RECOMMENDATION. MUST BE VERIFIED FOR SITE NATIONAL AND LOCAL CODES.
- GROUND WIRES INSIDE ENCLOSURES TO BE TAPED GREEN FOR ENTIRE VISUAL LENGTH FOR IDENTIFICATION.

1 MAIN BONDING JUMPER BETWEEN GROUNDED (NEUTRAL) CONDUCTOR AND EQUIPMENT GROUNDING CONDUCTOR TO BE PROVIDED IN FACILITY SERVICE EQUIPMENT AND DOWNSTREAM AT SEPARATELY DERIVED SYSTEM TRANSFORMER SECONDARY AS SHOWN.

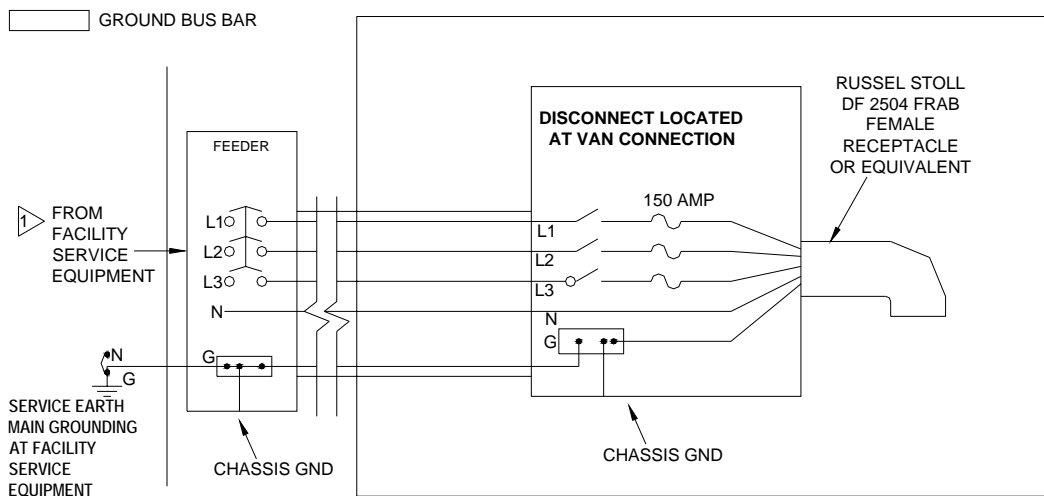

GROUNDING

The ground for our system shall originate at the system power source, i.e., transformer or first access point of power into a facility, and be continuous to our system power disconnect in the room. This ground can be spliced with "High Compression Fittings" and should be terminated at each distribution panel it passes through. When it is broken for a connection to a panel, it shall be connected into an approved grounding block with the incoming and outgoing ground in this same grounding block, which is then connected to the steel panel never using the steel panel never using the steel or other material of the panel as the block

The connection at the power source shall be at the grounding point of the "Neutral-Ground" if a "Wye" transformer is used, or typical grounding points of a separately derived system. In the case of an external facility, it shall be bonded to the facility ground point at the service entrance.

GROUNDING WIRE

The ground wire shall be copper wire with a minimum of AWG 1/0 or the same size as the power feeders whichever is larger. This means that if there is a primary feeder to a distribution panel of 500 MCM with a secondary feeder to our system of AWG 1/0 wire, the ground to the distribution panel shall be 500 MCM with and AWG 1/0 to our system. The ground wire impedance from our system disconnect, including the ground rod shall not have an impedance greater than 2 ohms to earth as measured by one of the applicable techniques described in Section 4 of ANSI/IEEE Standard 142-1982.

Harry E. Rauworth
Debra C. Balis
April 22, 1999

Telephone and Data Service Requirements

Telephone Service

The mobile unit is supplied with three (3) telephone connections. The connector type that is used is a Hubbell model PH-6595 (inlet) with a model PH-6624 connector body.

The customer is required to purchase and install three (3) Hubbell all weather telephone connections, model PH-6597 for use at the site.

Three Hubbell model PH-6599 telephone-connecting cables are included with the mobile unit. The cables measure 50'-0" in length.

Data Service

The mobile unit is supplied with two (2) data line connections that utilize RJ-45 outlets.

The customer is required to purchase the data connection cables for use with the data line connections. The data line connections require a 50'-0" CAT-5E cable with RJ-45 connections.

Water Requirements

IMPORTANT

During winter conditions, provisions must be made to ensure that water lines do not freeze because of weather conditions.

Water Supply Tank

A 35-gallon water supply tank is located on the left side of the mobile unit in the underbody compartments, which supplies the HVAC system.

The water supply tank can be filled from within the compartment by using the supplied adapter or from the exterior of the mobile unit by using the connection on the underbody compartment door and the supplied hose.

The drain for the water supply tank is located below the underbody compartment door. The drain valve is located in the underbody compartment.

Portable Sink (optional)

An optional portable self-contained sink is available. Within the portable sink assembly is the water supply and wastewater tank.

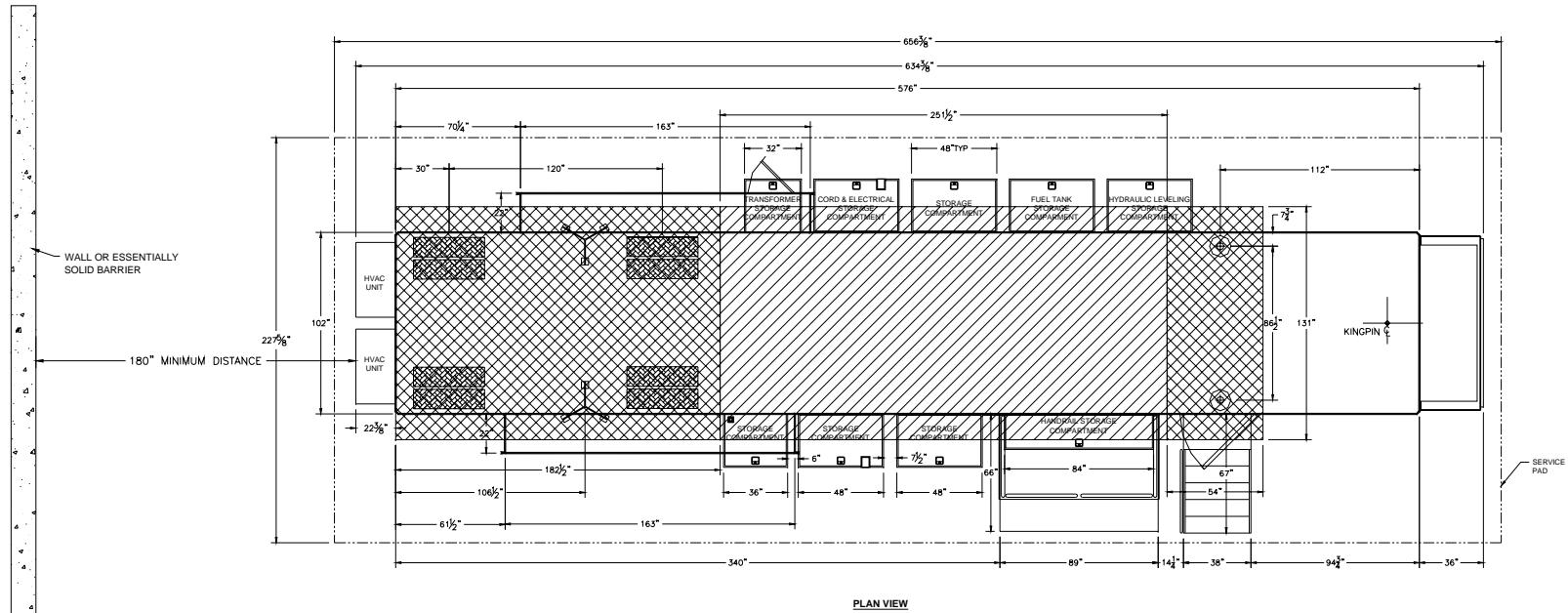

NOTE: IF TWO UNITS ARE PARKED BACK TO BACK, A MINIMUM DISTANCE OF 20" MUST BE MAINTAINED FROM COIL GRILL TO COIL GRILL OF THE A/C UNITS.

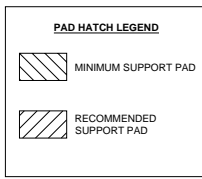
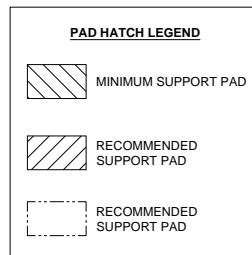
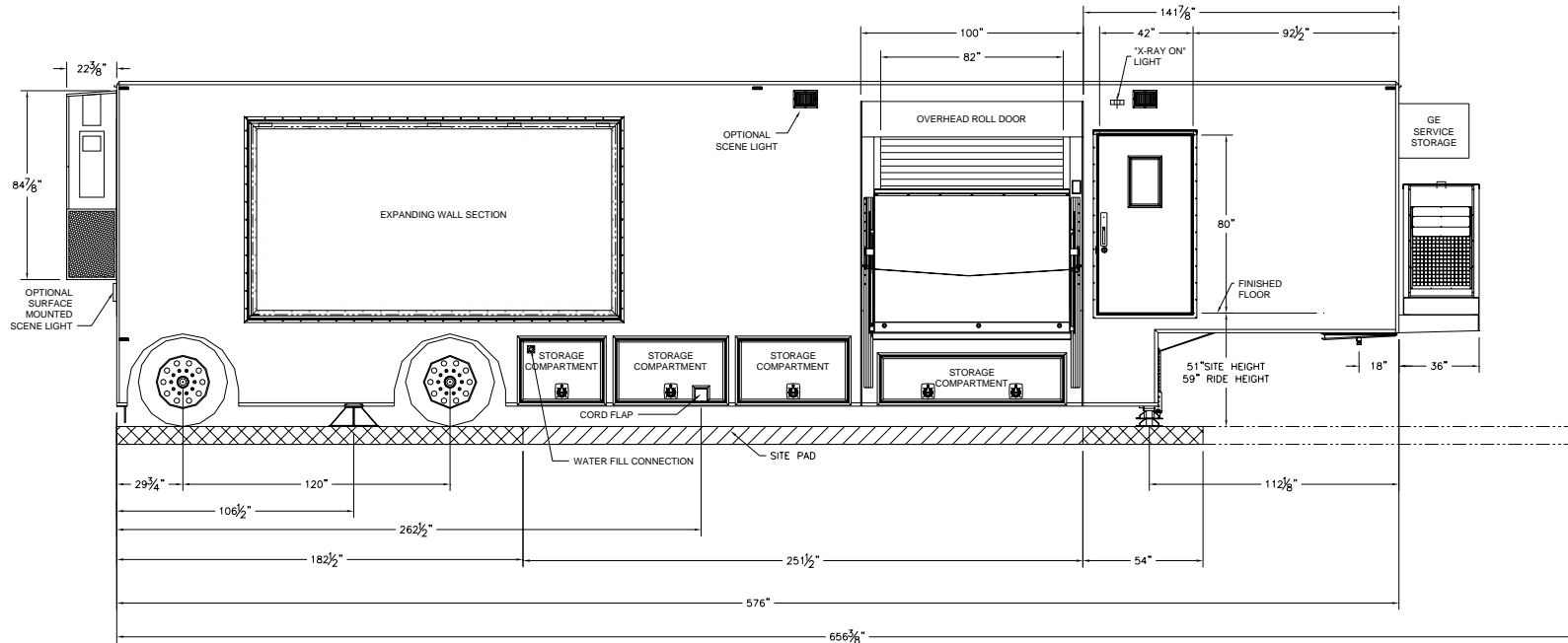
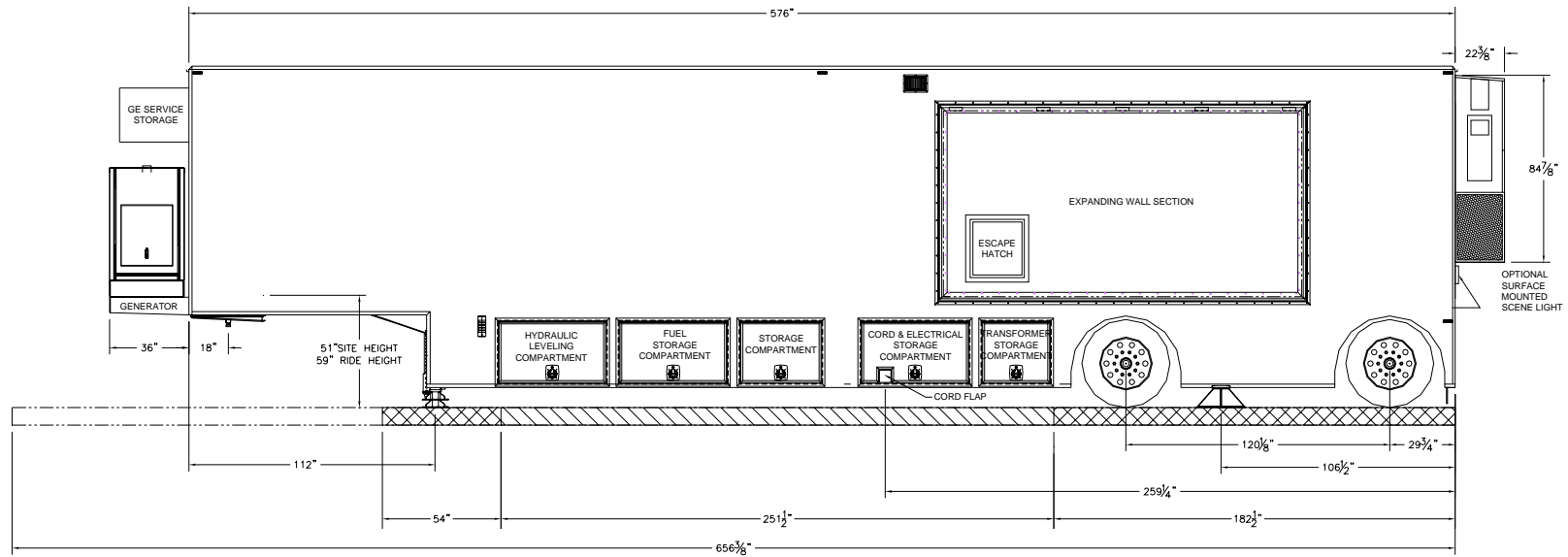

Figure 2: Plan Layout



*RIGHTSIDE
ELEVATION VIEW*

Figure 3: Right Side Elevation



*LEFTSIDE
ELEVATION VIEW*

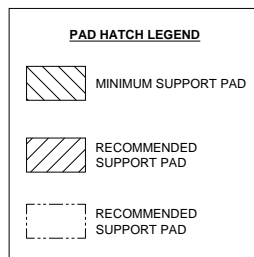

Figure 4: Left Side Elevation

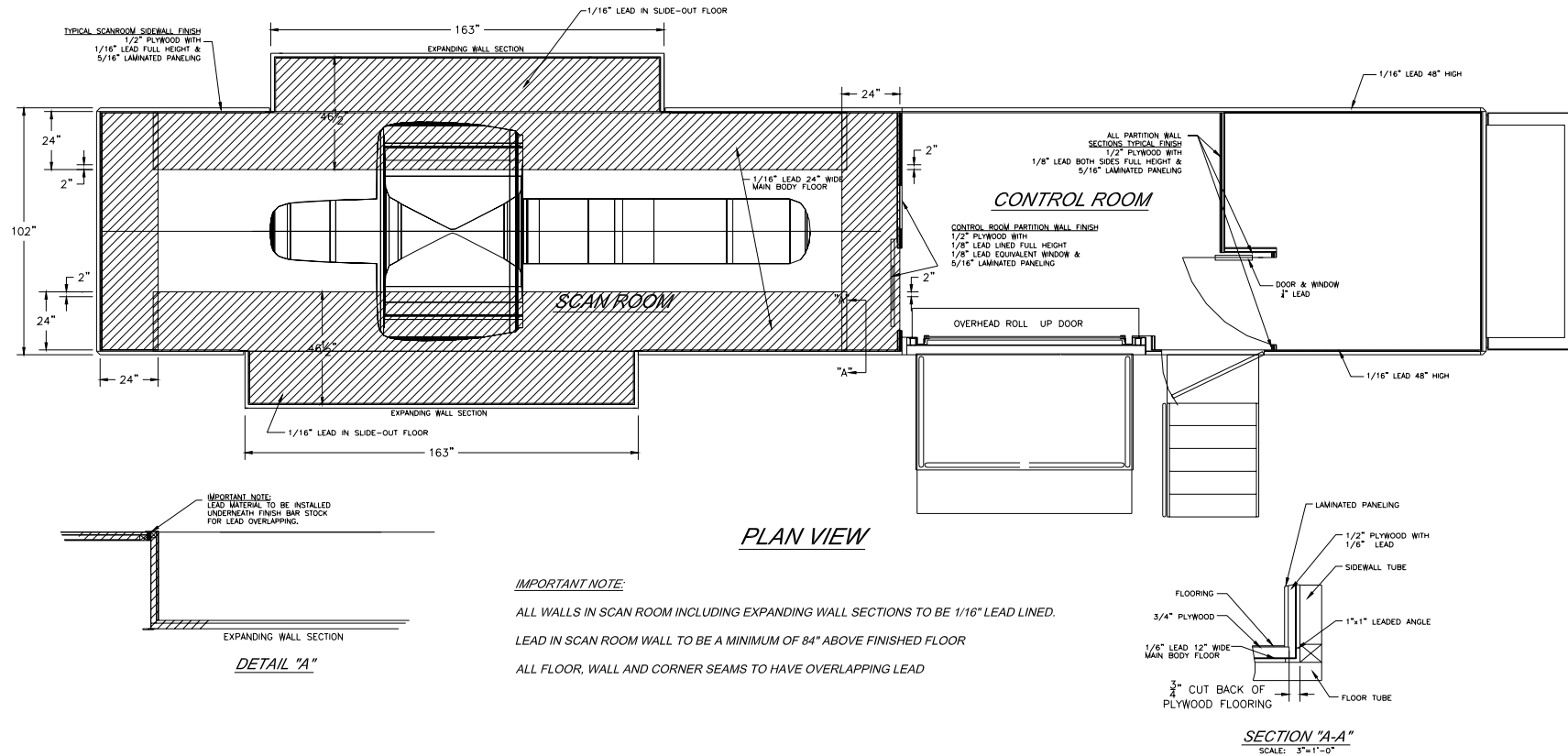

Figure 5: Radiation Shielding Plan View

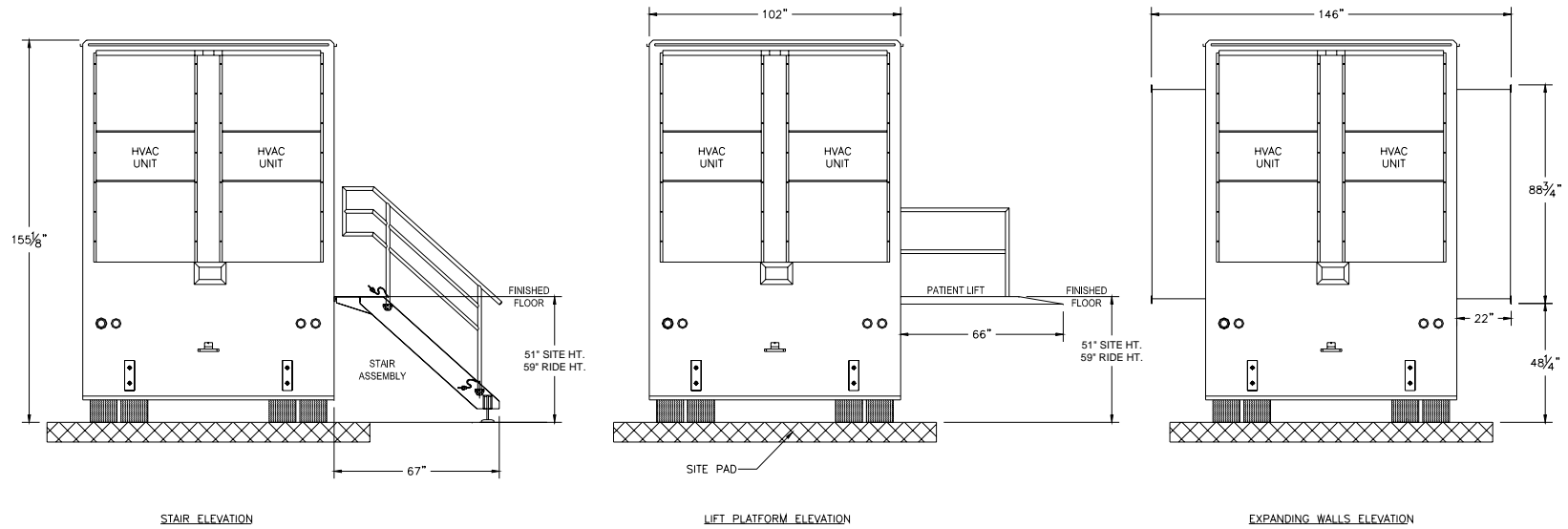

Figure 6: Stair / Lift / Wall Elevation

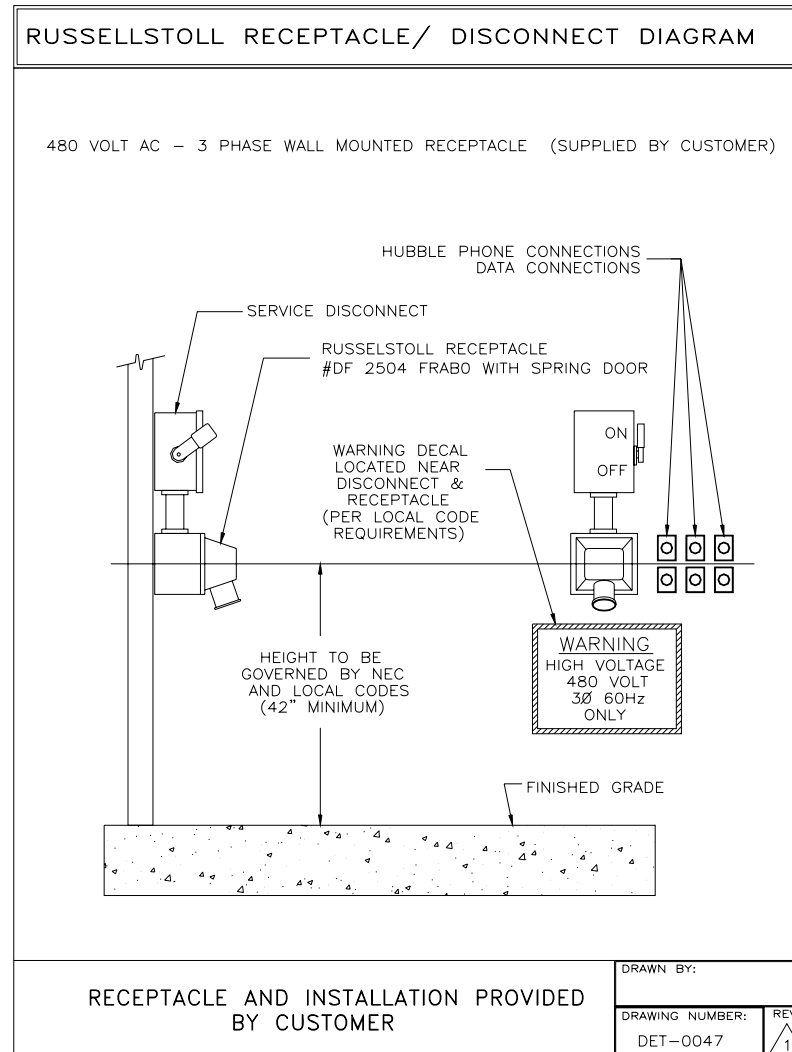

Figure 7: Russellstoll Receptacle, Service Disconnect

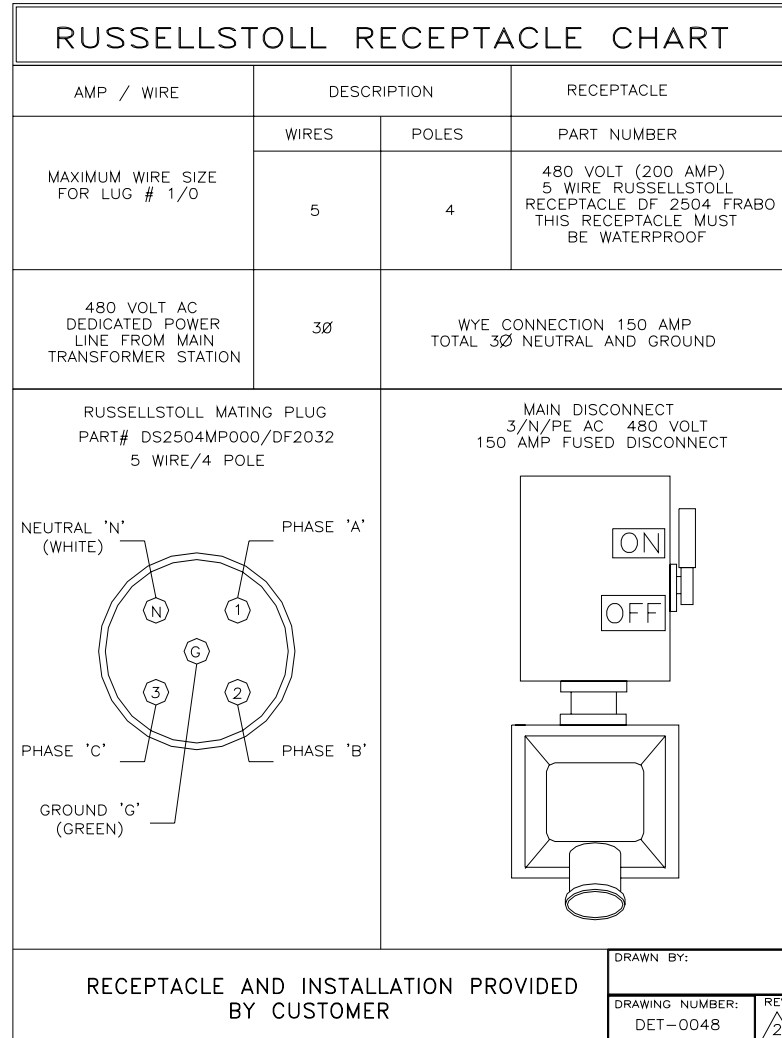

Figure 8: Russellstoll Receptacle Chart

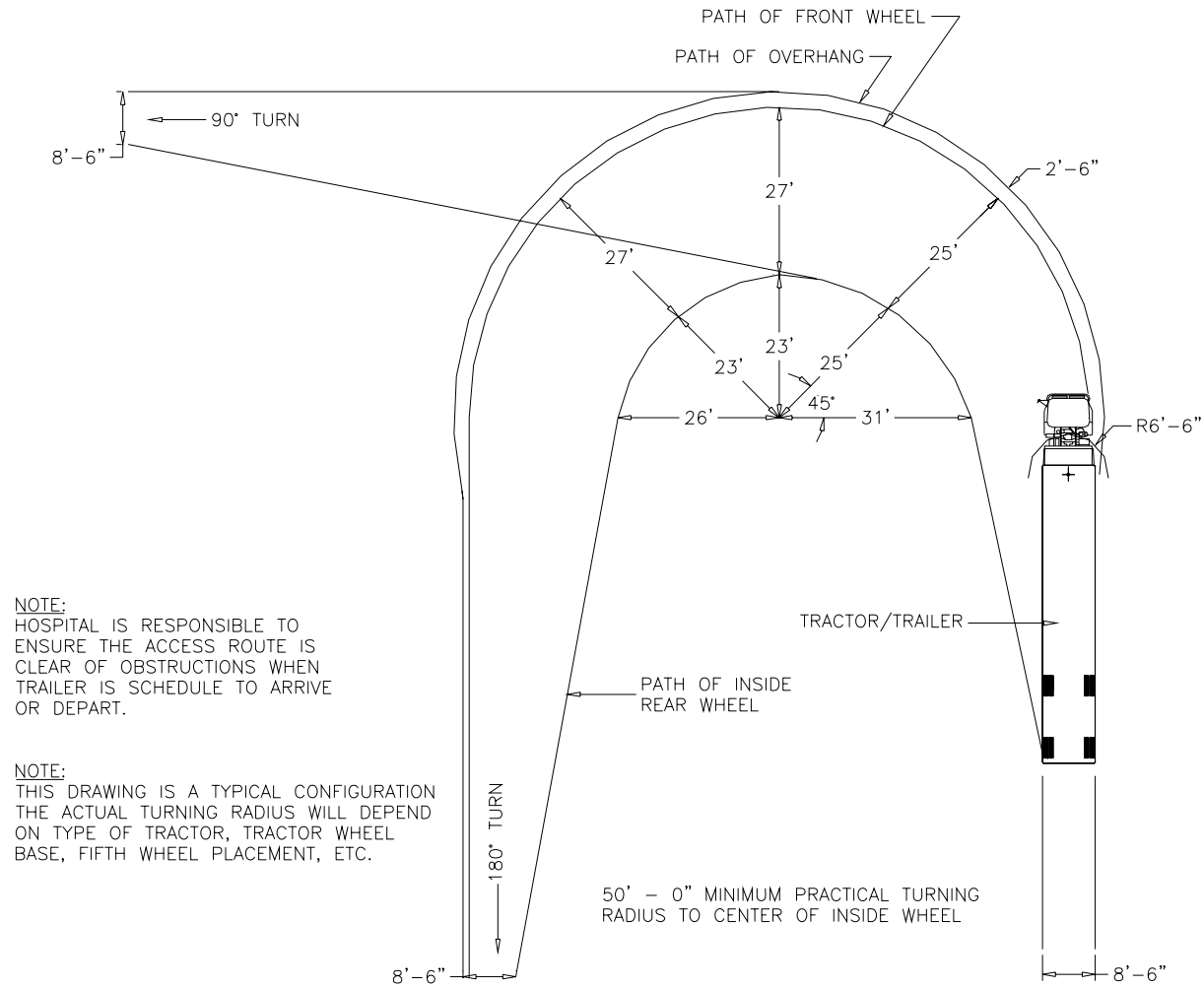

Figure 9: Turning Requirements